

Características | Especificaciones

Material
Material
Gresanit®

Aplicação
Fijación
À Parede
A la pared

Posicionamento do Pio
Posición del Cuba
Central | Al centro

Facas Vidradas
Superfícies Vidriadas
Visíveis
Mostradas
Todas
Totalidad
Y
1
N.A.

Garantia
Garantía
20 years
100%

Outras características técnicas
Otras especificaciones técnicas



Não adequado para instalar em móveis
No apto para instalar en muebles



403ZYXX2
[Cores | Colores](#)

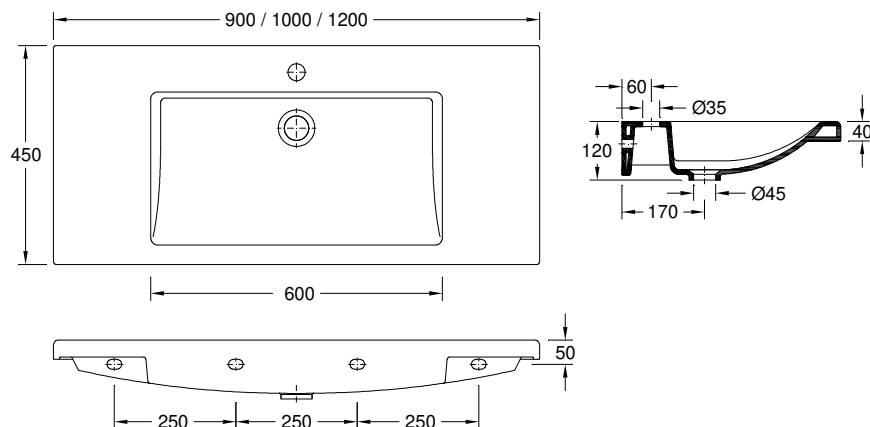

Desenho Técnico | Diseño Técnico



Dimensões | Dimensiones (mm)

Z	6	2	3
W	900	1000	1200
KG	21	22	26
L	450		
H	120		

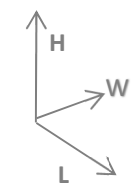

Componentes | Componentes

Incluído Incluido	Z - 6 2 3	55007001	2x Kit Fixação n.1 2x Kit Fijación n.1
Necessário Requirido	Coluna (se aplicável - consultar) Columna (si corresponde - consultar)		
	Torneira Grifo		
	Válvula de descarga Válvula de descarga		
	Sifão Sifón		

Recomendações | Recomendaciones!

PT ES

Material Material	Tipo de Peça Tipo de pieza	Detergentes Detergentes		Material de Limpeza Material de Limpieza		Outras Recomendações Otras recomendaciones
		✗	✓	✗	✓	
Cerâmicos Cerámicos		Abrasivos Abrasivos	Ácidos e Bases fracos Sabão Neutro Ácidos y bases débiles Jabón Neutro			 Evitar deixar cair objetos Evite dejar caer objetos
Metálicos Metálicos		Ácidos e Bases Acetona Álcool Amónia Abrasivos	Sabão Neutro Jabón Neutro	Abrasivos Abrasivos	Pano Suave Tejido suave	 Não se colocar na superfície do tempo No se pare sobre la superficie superior
Plásticos/Resinas Plástica/Resinas		Ácidos e Bases Acetona Álcool Amónia Abrasivos				 Não forçar a descida soft-close No fuerce el descenso de la tapa amortiguada

- PT - Outras recomendações mais específicas podem acompanhar os produtos comercializadas. Recomendamos que siga as recomendações e instruções indicadas.
EN - Other particular recommendations can be attached complementarily with the traded products. We strongly advise you to follow the recommendations and instructions indicated.

Specifications | Spécifications

Material
Matériel **Gresanit®**

Appliance
Application **To the wall**
Au Mur

Sink Position
Positionnement de l'évier **Centered** | Centré

Glazed Surfaces
Surfaces vitrées **Visible**
Visibles **Entirely**
Toutes **Y**
1
N.A.

Warranty
Garantie **20 years**
100%

Other technical features
Autres caractéristiques techniques: 

Not suitable for installing on furniture
Ne convient pas pour installation sur meubles



403ZYXX2
[Colours](#) | [Couleurs](#)



Technical Drawing | Dessin technique

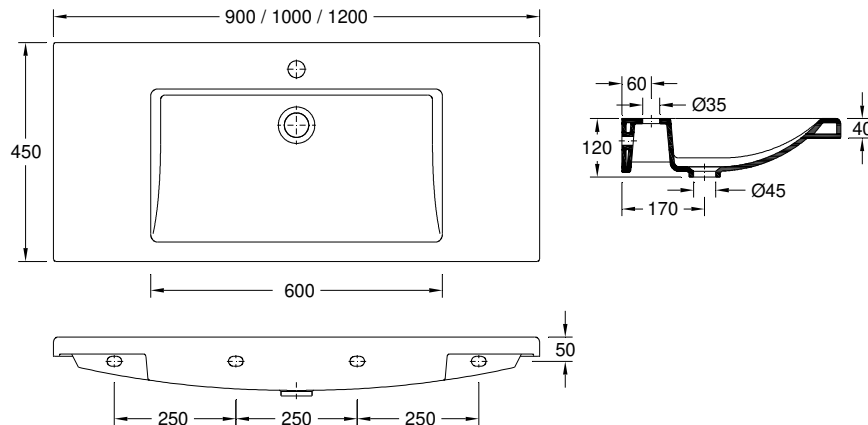

Dimensions | Dimensions (mm)

Z	6	2	3
W	900	1000	1200
KG	21	22	26
L	450		
H	120		

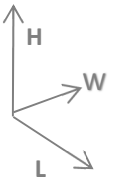









Components | Composants

Included Inclus	Z-6 2 3	55007001	2x Fixing Kit n.1 2x Kit d'installation N.1
Required Nécessaire	Pedestal (if applicable - check) Colonne (le cas échéant - consulter)		
	Tap Robinet		
	Discharge valve Bonde d'évacuation		
	Siphon Siphon		

Recommendations | Recommandations!

EN FR

Material Matériaux	Type of product Type de pièce	Detergents Détergents		Cleaning kit Matériel de Nettoyage		Other Recommendations Autres Recommandations
		✗	✓	✗	✓	
Ceramics Céramique		Abrasives Abrasifs	Acid and basic weak Neutral Soap Acides et bases faibles Savon Neutre	✗	✓	Attention / Attention  Not dropping objects Évitez de faire tomber des objets
Metallics Métallique		Acid and Basic Acetone Alcohol Ammonia Abrasives	Neutral Soap Savon Neutre	Abrasives Abrasifs	Cleaning Cloth Chiffon doux	 Weight on cover Ne vous tenez pas sur la surface supérieure  Effort on soft-close Ne forcez pas la descente en douceur
Plastics/Resins Plastiques/ Résines		Acides et Bases Acétone Alcool Ammoniac Abrasifs				

- PT - Outras recomendações mais específicas podem acompanhar os produtos comercializados. Recomendamos que siga as recomendações e instruções indicadas.
EN - Other particular recommendations can be attached complementarily with the traded products. We strongly advise you to follow the recommendations and instructions indicated.